



1989' dan
bu
yana

www.onkaprefabrik.com

*Ka*itest
ISO 9001 : 2008



Hakkımızda;

Tarihçemiz,

ONKA PREFABRİK 1987 yılından günümüze uzanan bilgi ve tecrübenin adıdır. İstanbul'da prefabrik sektörünün ilki temellerinin atılmasından bu yana geçen teknolojik gelişmeleri ve bilgi tecrübesini harmanlayan firmamız, ulusal ve uluslararası gelişmeleri yakından takip ederek sektörün geleceğine yatırım yapmaktadır.

Kalite,

ONKA PREFABRİK, her zaman olduğu gibi bugün de müşteri memnuniyetini ön plana alarak profesyonel ekibiyle geleceğe daha güvenle bakmaktadır. Kalite ve güvenilir ürün üretme, empatik ve süreklilik esaslı ile, asırlar geçse dahi ayakta kalarak, korumak ve geliştirmeyi ilke edinmiştir.

Hedefimiz,

Kalitenin sürekliliğini sağlamak, müşteri işlerine değer vermektir. Müşteri memnuniyetini her zaman kendisi için hedef edinen ONKA PREFABRİK yaptığı tüm işlerde garanti vererek, bundan sonraki faaliyet hayatında da edinmiş olduğu güvenilir ve istikrarlı yapısından taviz vermeden kalıcı hizmetler vermeye devam edecektir.

Misyonumuz,

Sürekli kendini geliştiren dinamik yapıyla üslenmiş olduğu projelerin kaliteden taviz vermeden hızlı ve ekonomik çözümlerle inşa ederken, sağlıklı, güvenli ve çevreye duyarlı çalışmayı ilke edinmiştir.

Vizyonumuz,

İnşaat projelerinde bireylerin ve kurumların güven duyarak taleplerini karşılandığı ve müşteri memnuniyetinin ön planda tutulduğu bir firma olarak insanlara modern ve konforlu hayat tarzı sunan yapılar üreten lider firmalar arasında yerini almıştır.

www.onkaprefabrik.com



Faaliyet Alanlarımız;

Prefabrik Tek Katlı ve Dubleks Konut Üretimi, Dubleks Villa Üretimi, Sosyal Tesis Üretimi, Okul, Yemekhane ve Yatakhane Üretimi, Çelik Bina, Fabrika ve Hangar Üretimi, Konteyner Üretimi, WC ve Duş Sistemleri Üretimi, Baraka Üretimi, Şantiye Binaları, Bekçi Kulubeleri Üretim





57 m² (50m² + 7m²)
KAT PLANI



04



68 m² (61m² + 7m²)
KAT PLANI

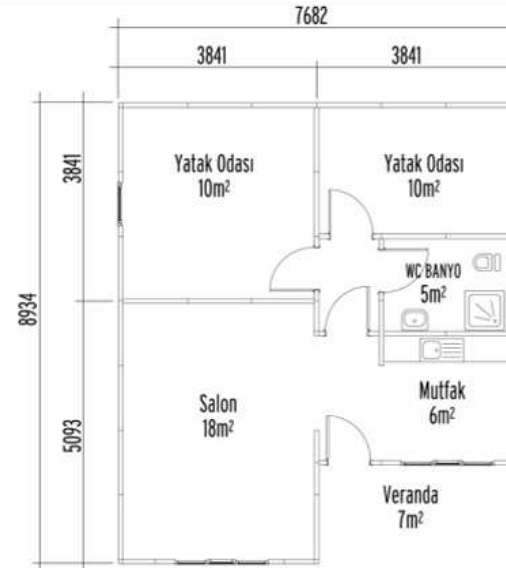

05



78 m² (68m² + 10m²)
KAT PLANI

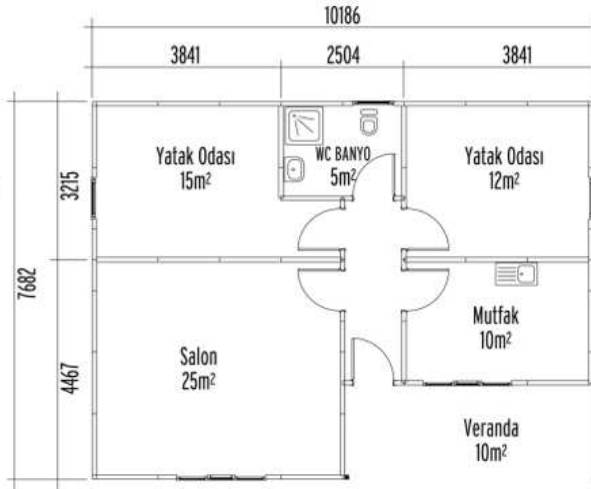

06



105 m² (99m² + 6m²)
KAT PLANI

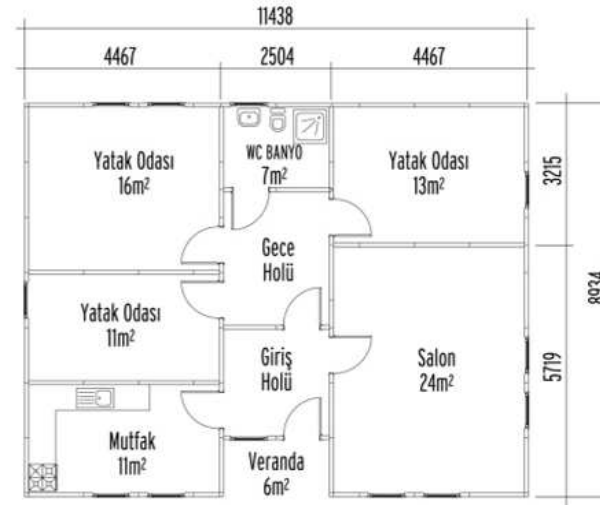

07



71 m² (58m² + 13m²)
ZEMİN KAT PLANI

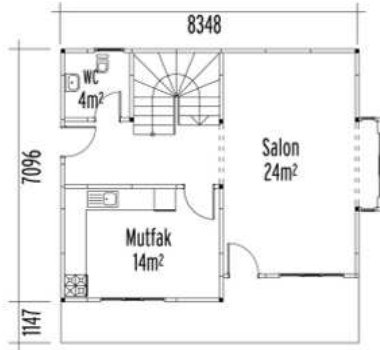

64 m²
1. KAT PLANI



67 m² (67m² + 21m²)
ZEMİN KAT PLANI

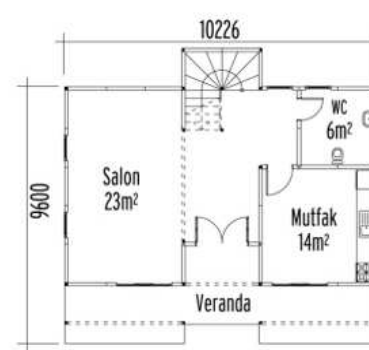

67 m²
1. KAT PLANI

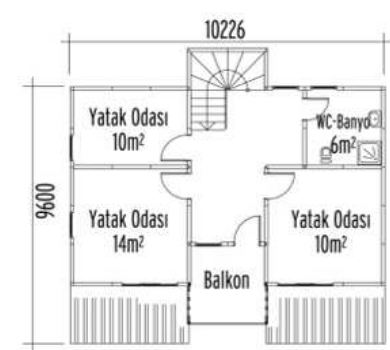



Prefabrik Binalar



Prefabrik Binalar



Ofis Binaları

53 m²
Cumbalı Ofis Binası

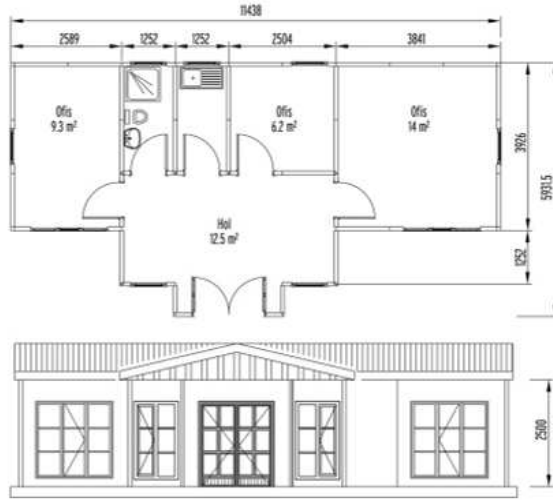

Ofis Binaları

170 m²
Ofis Binası

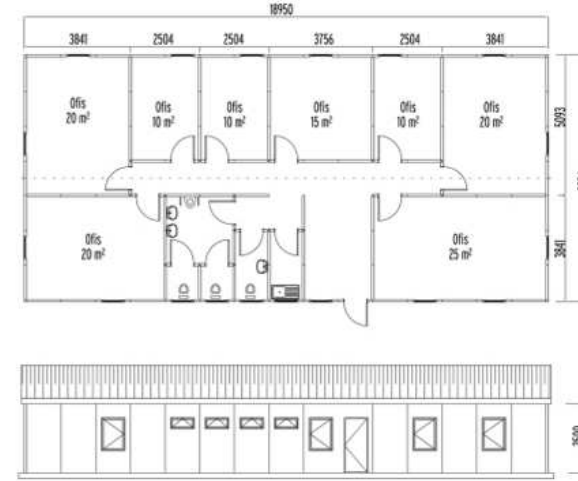

103 m²
Ofis Binası

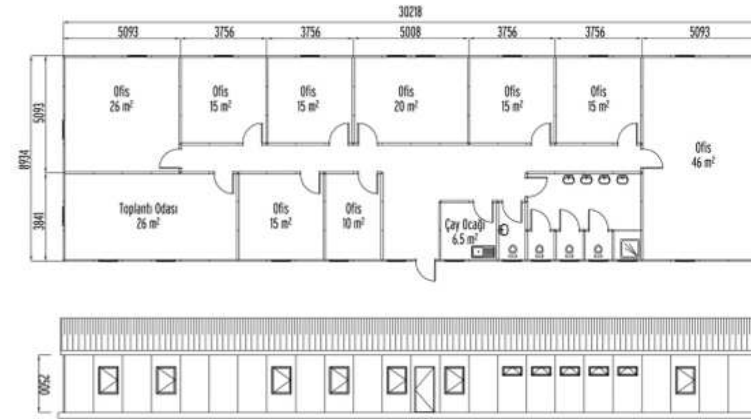
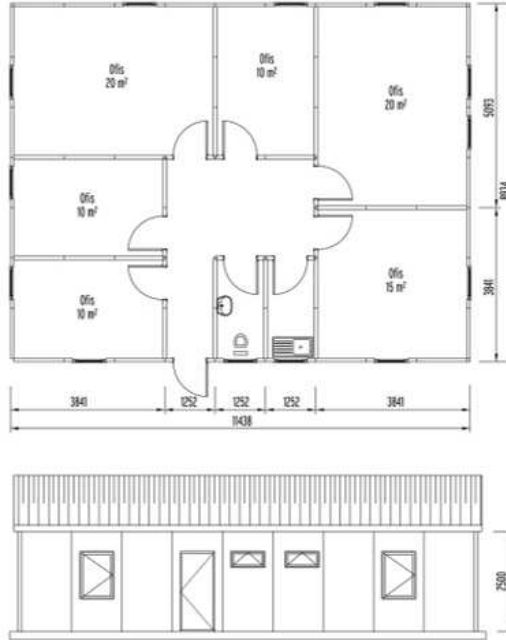

271 m²
Prefabrik
Ofis Binası



Yatakhane Binaları

52 m²
Yatakhane
Binası

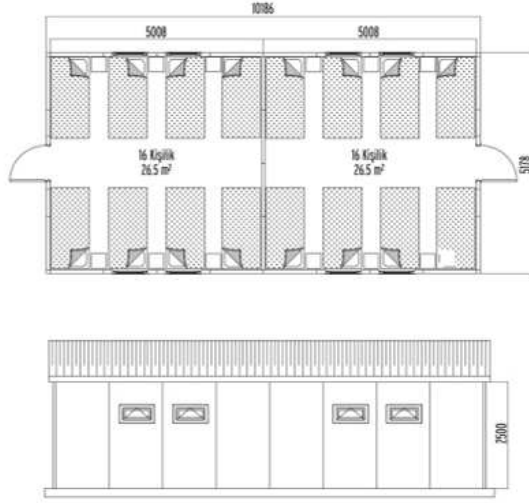

Yatakhane Binaları

181 m²
Yatakhane
Binası

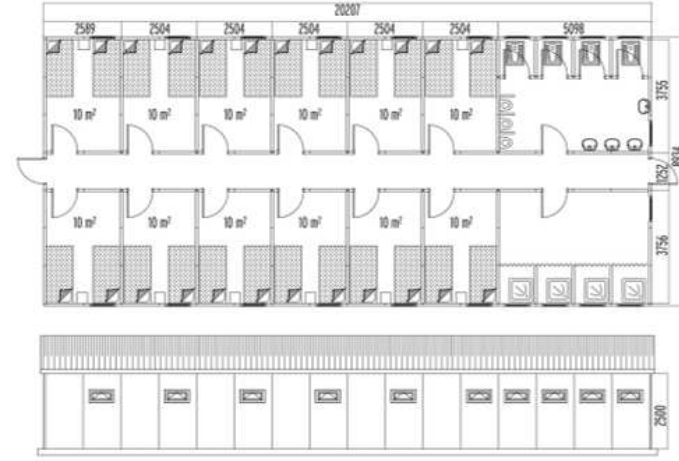

147 m²
Yatakhane
Binası

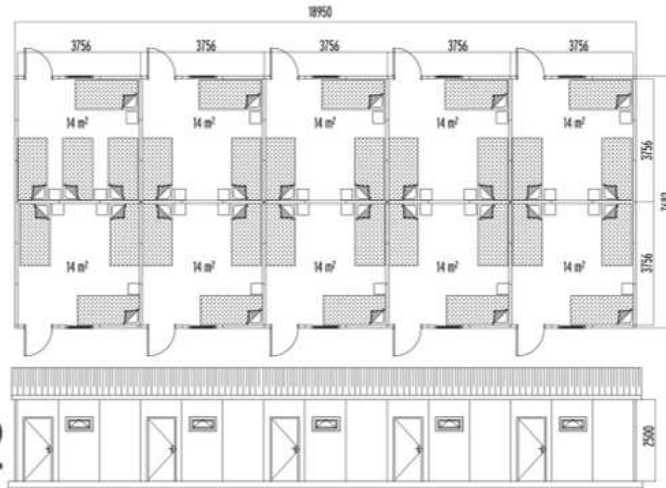

226 m²
Yatakhane
Binası

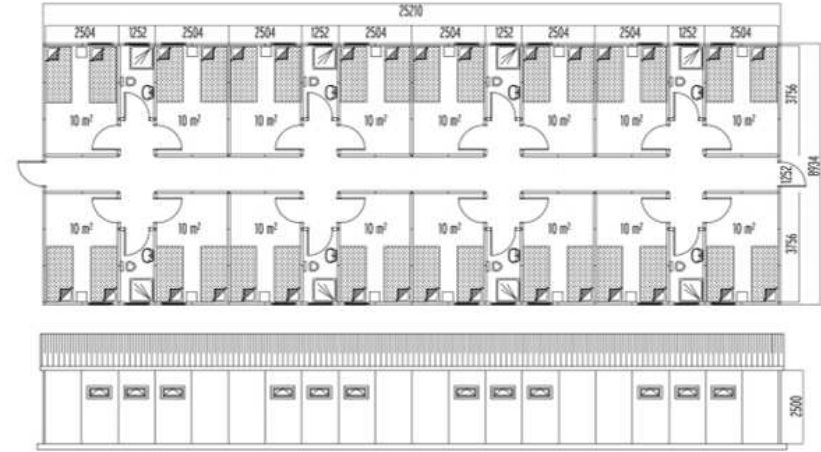

Yemekhane Binaları

65 m²
Yemekhane
Binası

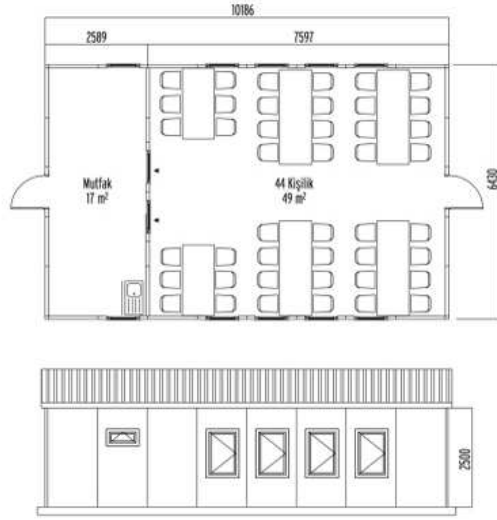

Yemekhane Binaları

159 m²
Yemekhane
Binası

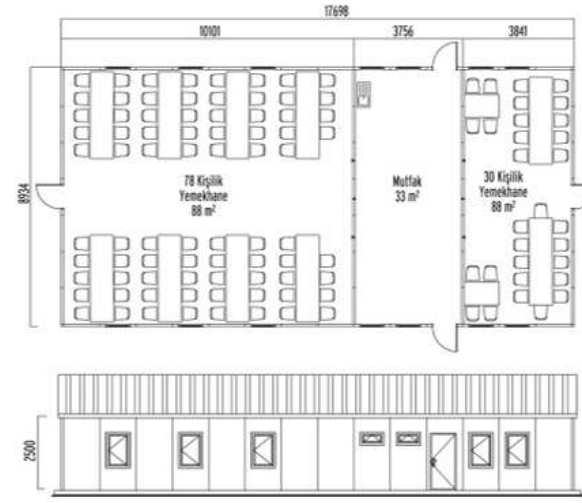

126 m²
Yemekhane
Binası

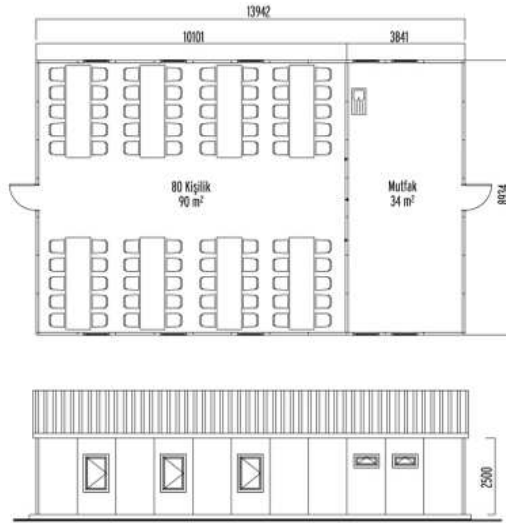

460 m²
Prefabrik
Ofis Binası

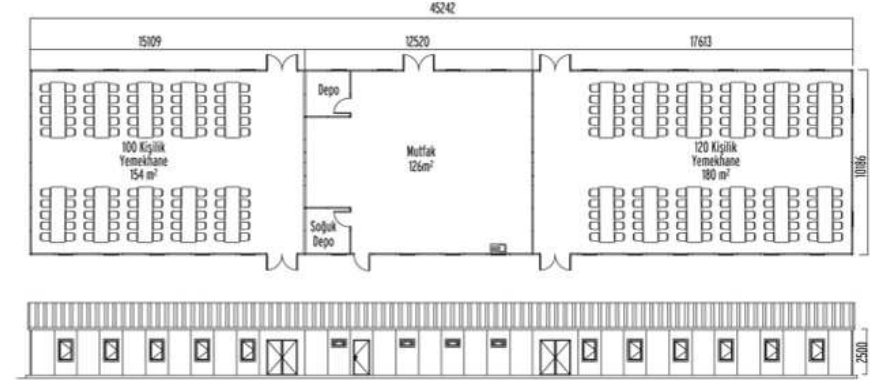

Sosyal Binalar

97 m²
Bina

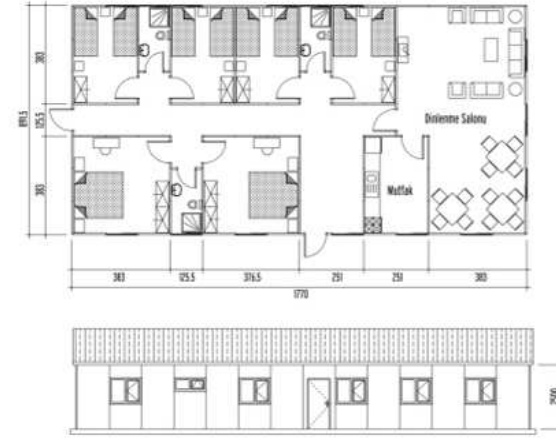
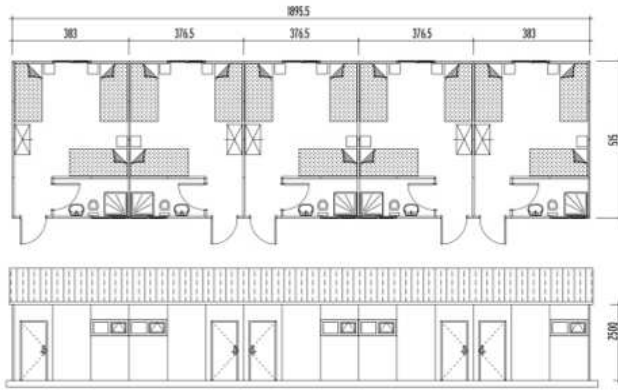

Sosyal Binalar

157 m²
Kamp Binası

112 m²
Revir Binası

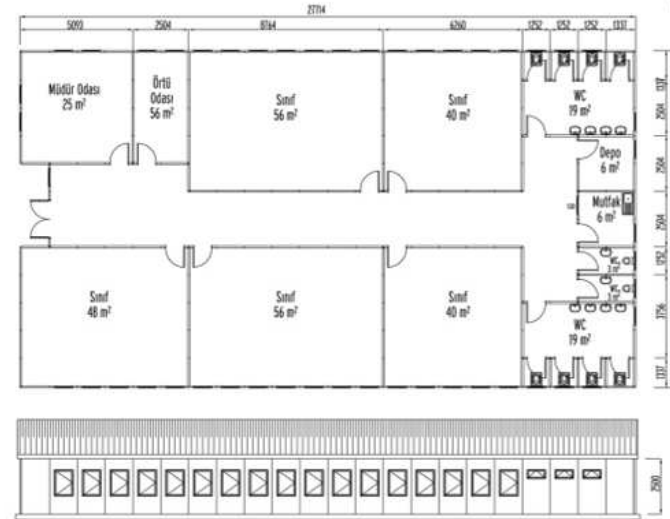

421 m²
Okul Binası

WC - DUŞ

13 m²
WC - DUŞ

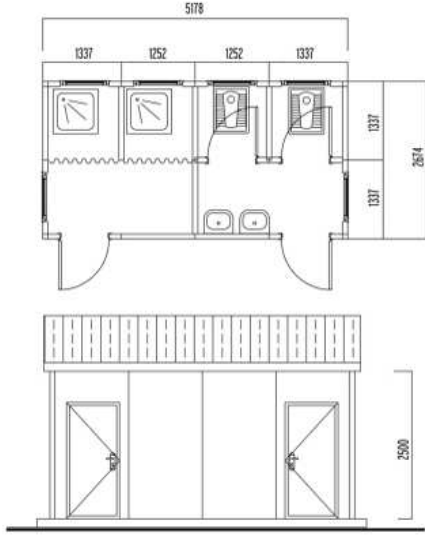

WC - DUŞ

52 m²
WC - DUŞ
Binası

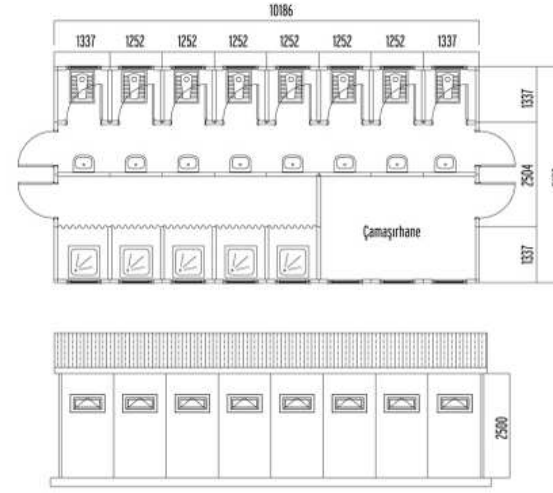

26 m²
WC - Duş
Binası

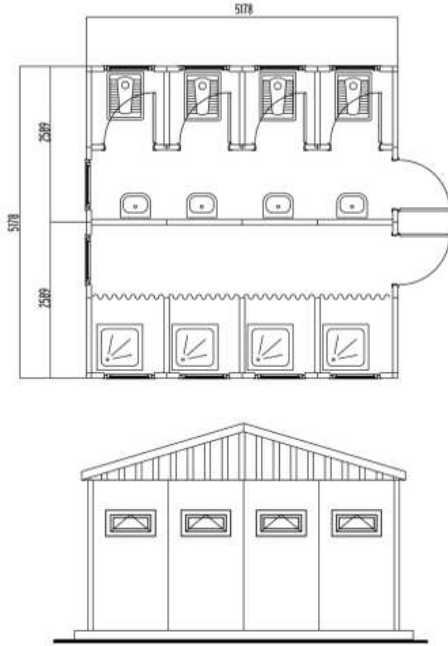

52 m²
WC - DUŞ
Binası

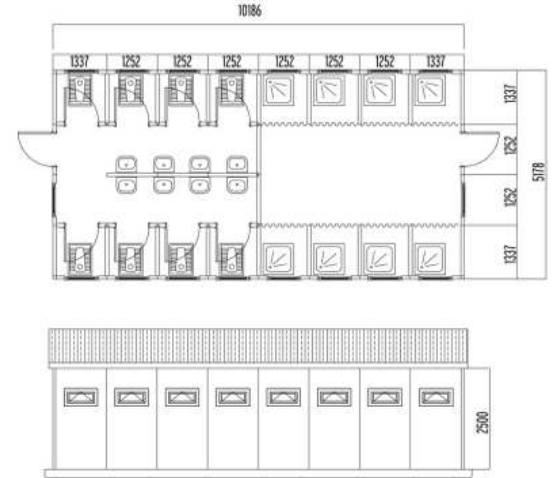

Özel Tasarımlar



Özel Tasarımlar



Özel Tasarımlar





Konteynerler



Konteynerler



300x700 (İstenilen Ebatlarda Üretilmektedir.)

Konteynerler

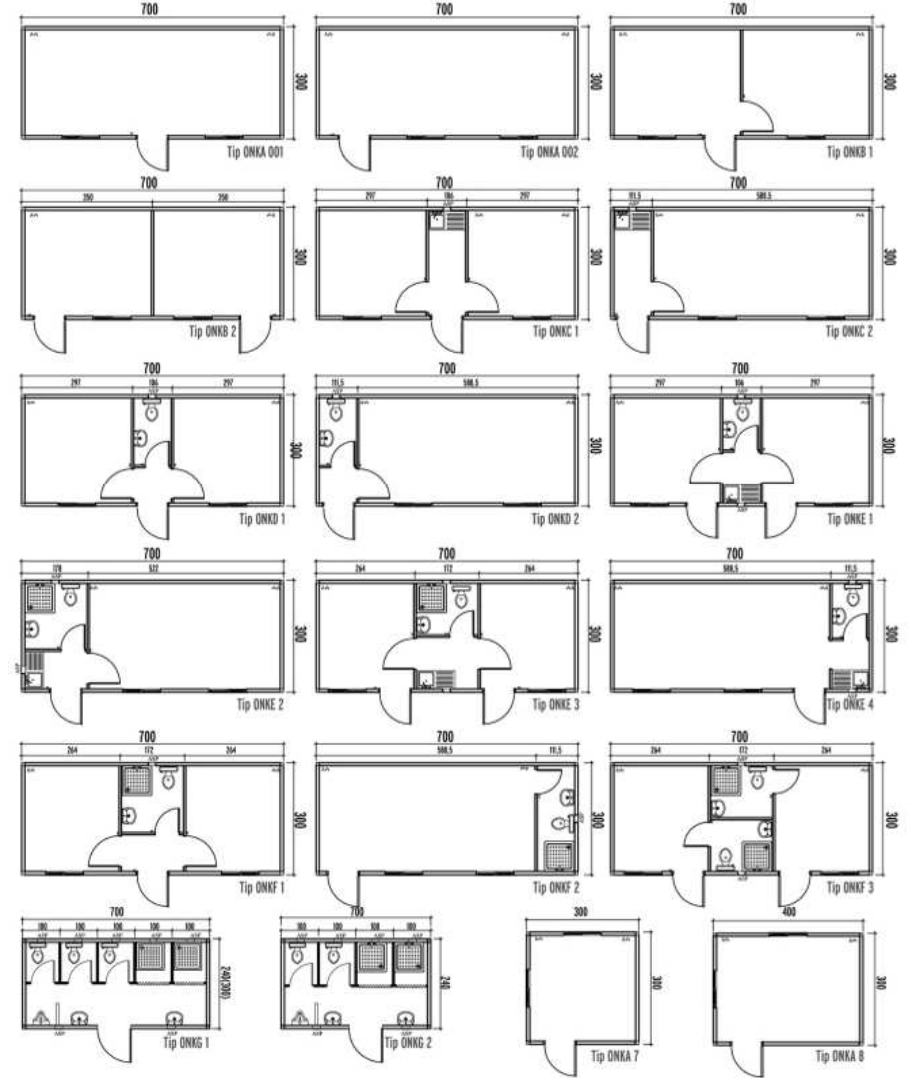

**130 x 130**

Ebat - Dimension : 1.30 x 1.30 m
 Yükseklik - Height : 2.40 m
 Ağırlık - Weight : 290 kg
 Alan - Space : 2.25 m²

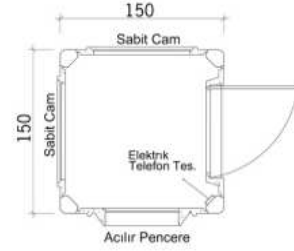
**150 x 150**

Ebat - Dimension : 1.50 x 1.50 m
 Yükseklik - Height : 2.40 m
 Ağırlık - Weight : 290 kg
 Alan - Space : 2.25 m²

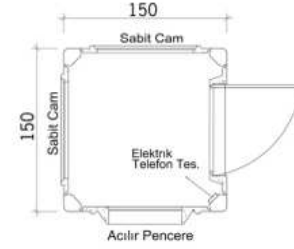
**150 x 220**

Ebat - Dimension : 1.50 x 2.20 m
 Yükseklik - Height : 2.40 m
 Ağırlık - Weight : 395 kg
 Alan - Space : 3.30 m²

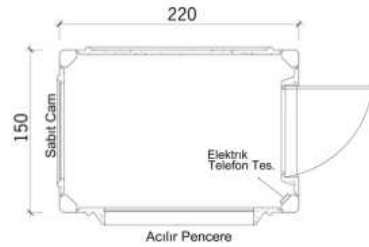

Ebat - Dimension : 1.50 x 2.70 m
 Yükseklik - Height : 2.40 m
 Ağırlık - Weight : 450 kg
 Alan - Space : 4.05 m²

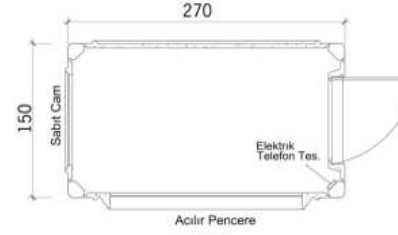
150 x 270

Ebat - Dimension : 2.20 x 2.20 m
 Yükseklik - Height : 2.40 m
 Ağırlık - Weight : 500 kg
 Alan - Space : 4.84 m²

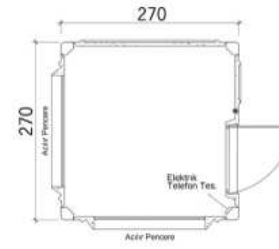
220 x 220

Ebat - Dimension : 2.20 x 2.70 m
 Yükseklik - Height : 2.40 m
 Ağırlık - Weight : 550 kg
 Alan - Space : 5.94 m²

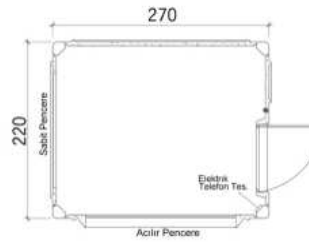
220 x 270

**270 x 270**

| | |
|--------------------|-----------------------|
| Ebat - Dimension | : 2.70 x 2.70 m |
| Yükseklik - Height | : 2.40 m |
| Ağırlık - Weight | : 650 kg |
| Alan - Space | : 7.29 m ² |

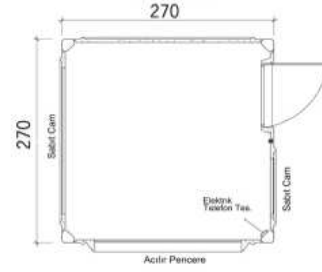
**220 x 390**

| | |
|--------------------|-----------------------|
| Ebat - Dimension | : 2.20 x 3.90 m |
| Yükseklik - Height | : 2.40 m |
| Ağırlık - Weight | : 750 kg |
| Alan - Space | : 8.58 m ² |

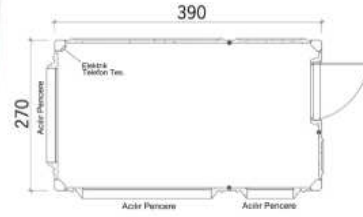
**270 x 390**

| | |
|--------------------|------------------------|
| Ebat - Dimension | : 2.70 x 3.90 m |
| Yükseklik - Height | : 2.40 m |
| Ağırlık - Weight | : 800 kg |
| Alan - Space | : 10.53 m ² |

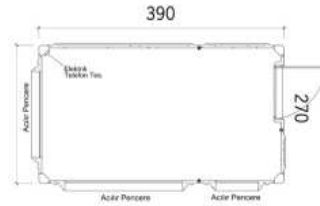

| | |
|--------------------|------------------------|
| Ebat - Dimension | : 2.70 x 5.10 m |
| Yükseklik - Height | : 2.40 m |
| Ağırlık - Weight | : 950 kg |
| Alan - Space | : 13.77 m ² |

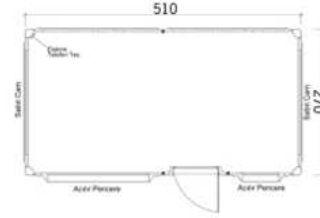
270 x 510

| | |
|--------------------|------------------------|
| Ebat - Dimension | : 2.70 x 6.30 m |
| Yükseklik - Height | : 2.40 m |
| Ağırlık - Weight | : 1300 kg |
| Alan - Space | : 17.01 m ² |

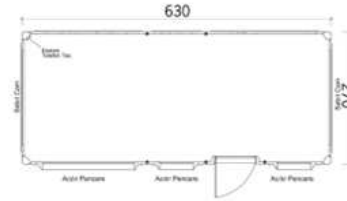
270 x 630

| | |
|--------------------|------------------------|
| Ebat - Dimension | : 2.70 x 7.50 m |
| Yükseklik - Height | : 2.40 m |
| Ağırlık - Weight | : 1600 kg |
| Alan - Space | : 20.25 m ² |

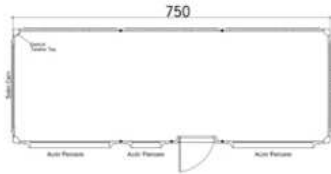
270 x 750



MODÜLER POLYESTER WC-DUŞ KABİN PLANLARI

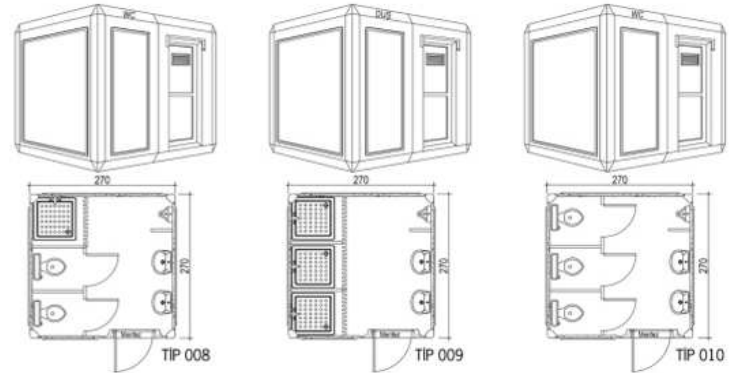
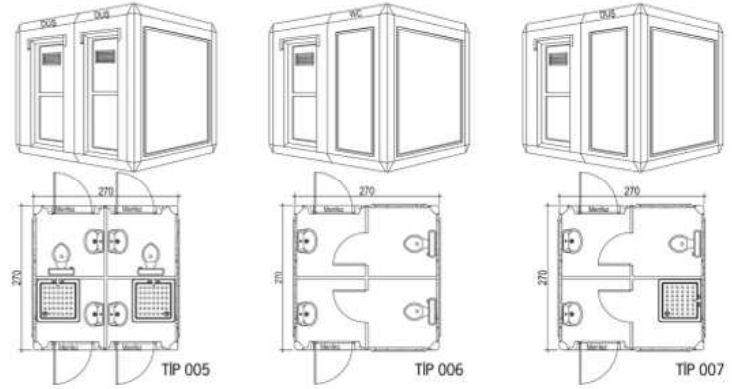
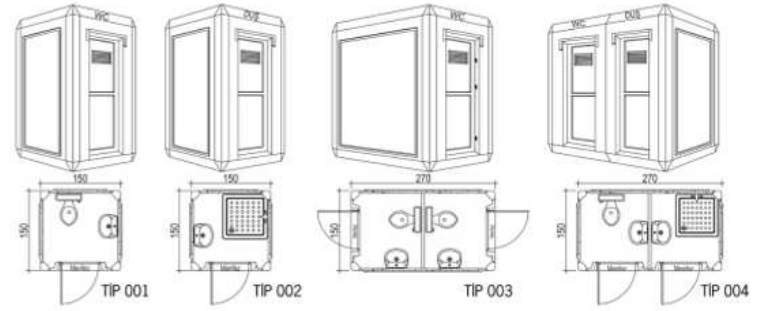

Çadırlar



Balonlar



www.onkaprefabrik.com



Danışmanlık: AVANTİ 492163923306 01011



Onka Prefabrik Sanayi Ticaret Limited Şirketi

İçmeler Mahallesi E-5 Yanyol

Erdem Sokak No.:19 34031

Tuzla - İSTANBUL

Tel. : 0216 392 83 93 (pbx)

Faks : 0216 392 15 40

info@onkaprefabrik.com

www.onkaprefabrik.com